

CONSUMABLES HANDBOOK

Rev.5.0

 Hitachi High-Tech Science Corporation

Japan: <https://www.hitachi-hightech.com/global/about/corporate/group/hhs/>
Other Regions/Countries: <https://www.hitachi-hightech.com/global/about/corporate/group/hhs/distribution.html>

Distributor's Contact

February 2020

2020-HHSEL-TA01E

CONTENTS

	PAGE
Sample Pans	1-1
Sample Sealer	1-5
Parts for Thermomechanical Analyzer (TMA) (TMA/SS)	1-9
Parts for Differential Scanning Calorimetry (DSC)	1-15
Auto Gas Cooling Unit	1-17
Parts for Simultaneous Thermogravimetric Analyzer (STA) (TG/DTA)	1-19
Parts for Dynamic Mechanical Analyzer (DMA) (DMS)	1-21

* Products with ★ in front of item number will be arranged after receiving order form.
Please contact us for delivery date.

* The black circled numbers (①, ②...) correspond to the number of photo/figure

* Please note that the changing of quantity, deletion of item code may occur without prior notice.

* For EXSTAR6000 Series, the maintenance parts availability deadline will be Nov, 2019 (part in Feb, 2020).

The specifications and appearance of products listed in this document is subject to change without prior notice for improvement.





The contents listed in this documents are as of Feb 2020.

Safety Precautions



Before using the instruments, read the operation manual carefully and properly.

Sample Pans

Open-type Sample Pans and Covers

Name	Open Sample Pans (Al)		Crimp Pan Covers (Al)	Cover Plates (Al)
	1	2	3	4
				
Part No.	GAA-0068	GCA-0055	GAA-0069	GAA-0142
Qty	200pcs/pck x 2 packs	200pcs/pack	200pcs/pck x 2 packs	200pcs/pck x 2 packs
Remarks	φ5.2 h2.5 (mm)	φ5.2 h5.0 (mm)	φ5.0 mm	φ5.0 mm

Name	Open Sample Pans (Pt)		Cover Plates (Pt)	Open Sample Pans (Ceramic)
	5	6	7	8
				
Part No.	CSF-6410	CSF-6411	GAA-0424	GAA-0435
Qty	5pcs/pack	5pcs/pack	5pcs/pack	5pcs/pack
Remarks	φ5.2 h2.5 (mm)	φ5.2 h5.0 (mm)	φ5.0 mm	φ5.2 h2.5 (mm)

Name	Open Sample Pans (Ceramic)	Open Sample Pans (Cu)	Open Pan Mesh Covers (Cu)	Open Pan Mesh Covers (SS)
	9	10	11	12
				
Part No.	GAA-1980	GCA-0028	GCA-0029	GAA-0495
Qty	5pcs/pack	200pcs/pack	200pcs/pack	200pcs/pack
Remarks	φ5.2 h5.0 (mm)	φ5.2 h2.5 (mm)	φ5.0 mm	φ5.0 mm

Low-pressure Sealed Pans with Covers

Name	Sealed Pans & Covers (Al)		Sealed Pans & Covers (Chromated Al)	
	13	14	15	16
				
Part No.	GCA-0052	CVB-0008	GCA-0053	CVB-0009
Qty	200sets/pack	100sets/pack	200sets/pack	100sets/pack
Remarks	0.3MPa 7.5 uL	0.3MPa 40 uL	0.3MPa 7.5 uL	0.3MPa 40 uL

Sample Pans

※Encircled numbers correspond to "No." column on pages 1-3 to 1-4

High-pressure Sealed Pans with Covers



Name	Sealed Pans & Covers (Al)		Sealed Pans & Covers (Ag)	
	17	18	19	20
				
Part No.	GCA-0017	GCA-0018	GCA-0022	GCA-0021
Qty	40sets/pack	40sets/pack	20sets/pack	20sets/pack
Remarks	3.0MPa 15 uL	3.0MPa 70 uL	5.0MPa 15 uL	5.0MPa 70 uL

Name	Sealed Pans & Covers (SS)		Slid. Pans & Cvr. (Gold-plated SS)
	21	22	23
			
Part No.	GCA-0023	GCA-0051	GAA-0462
Qty	20sets/pack	20sets/pack	10sets/pack
Remarks	5.0MPa 15 uL	5.0MPa 70 uL	5.0MPa 15 uL

Open Pans for Auto Sampler (DSC)

Name	RDC Sample Pan (Al)	RDC Sample Pan Cover (Al)
	24	25
		
Part No.	GAA-0065	GAA-0064
Qty	200pcs/pack	200pcs/pack
Remarks	15 uL φ6.8 h2.5	φ6.8 mm

PDC Sample Pans and Plate

Name	PDC Open Sample Pan (Al)	PDC Open Sample Pan Cover (Al)	PDC Sample Plate (Al)
	26	27	28
			
Part No.	GCA-0057	K-YSSC000E036	GCA-0020
Qty	200pcs/pck x 2 packs	200pcs/pck x 2 packs	200pcs/pack
Remarks	50 uL φ7.2 h1.5	φ7.0 mm	φ6.5 mm

Sample Pans and Applicable Modules

※ Encircled numbers correspond to "No." column on pages 1-1 to 1-2

No.	Part Number	Part Name	Corresponding Part	Specifications						Water Max. Temp. (°C)*5	Applicable Products						No.
				Material	Φ (mm)	Height (mm)	Capacity (μL)	Max Temp (°C)	Pressure Upper Limit (MPa)		DSC 6100	DSC 6200/6220	DSC 6300	DSC 7020	DSC 7000X*1	STA*2	
Open-type Sample Pans and Covers																	
1	GAA-0068	Open Sample Pans (Al) φ5.2 h2.5 (200pcs/pck x 2 packs)	3 GAA-0069 / 4 GAA-0142	Al	5.2	2.5	45	600	/	/	○	○	○	○	○	○	1
2	GCA-0055	Open Sample Pans (Al) φ5.2 h5.0 (200pcs/pck)	4 GAA-0142	Al	5.2	5.0	95	600	/	/	○	—	—	—	—	○	2
3	GAA-0069	Crimp Pan Covers (Al) φ5.0 (200pcs/pck x 2 packs)	1 GAA-0068	Al	5.0	/	/	600	/	/	○	○	○	○	○	—	3
4	GAA-0142	Cover Plates (Al) φ5.0 (200pcs/pck x 2 packs)	1 GAA-0068 / 2 GCA-0055	Al	5.0	/	/	600	/	/	○	○	○	○	○	—	4
5	CSF-6410	Open Sample Pans (Pt) φ5.2 h2.5 (5pcs/pck)	7 GAA-0424	Pt	5.2	2.5	45	1500	/	/	○	○	○	○	○	○	5
6	CSF-6411	Open Sample Pans (Pt) φ5.2 h5.0 (5pcs/pck)	7 GAA-0424	Pt	5.2	5.0	95	1500	/	/	○	—	—	—	—	○	6
7	GAA-0424	Cover Plates (Pt) φ5.0 (5pcs/pck)	5 CSF-6410 / 6 CSF-6411	Pt	5.0	/	/	1500	/	/	○	○	○	○	○	—	7
8	GAA-0435	Open Sample Pans (Ceramic) φ5.2 h2.5 (5pcs/pck)	/	Alumina	5.2	2.5	25	1500	/	/	○	○	○	○	○	○	8
9	GAA-1980	Open Sample Pans (Ceramic) φ5.2 h5.0 (5pcs/pck)	/	Alumina	5.2	5.0	60	1500	/	/	○	—	—	—	—	○	9
10	GCA-0028	Open Sample Pans (Cu) φ5.2 h2.5 (200pcs/pck)	11 GCA-0029	Cu	5.2	2.5	45	220	/	/	○	○	○	○	○	○	10
11	GCA-0029	Open Pan Mesh Covers (Cu) φ5.0 (200pcs/pck)	10 GCA-0028	Cu	5.0	/	/	220	/	/	○	○	○	○	○	○	11
12	GAA-0495	Open Pan Mesh Covers (SS) φ5.0 (200pcs/pck)	/	SUS	5.0	/	/	220	/	/	○	○	○	○	○	○	12
Low-pressure Sealed Pans with Covers																	
13	GCA-0052	Sealed Pans & Covers (Al) 0.3MPa 7.5 uL (200sets/pck)	/	Al	6.8	2.6	7.5	500	0.3	134	○	○	—	○	○	—	13
14	CVB-0008*4	Sealed Pans & Covers (Al) 0.3MPa 40 uL (100sets/pck)	/	Al	6.8	5.1	40	200	0.3	134	○	—	—	○	○	—	14
15	GCA-0053	Slid. Pans & Cvr. (Chromated Al) 0.3MPa 7.5 uL (200sets/pck)	/	Al	6.8	2.6	7.5	300	0.3	134	○	○	—	○	○	—	15
16	CVB-0009*4	Slid. Pans & Cvr. (Chromated Al) 0.3MPa 40 uL (100sets/pck)	/	Al	6.8	5.1	40	200	0.3	134	○	—	—	○	○	—	16
High-pressure Sealed Pans with Covers																	
17	GCA-0017	Sealed Pans & Covers (Al) 3.0MPa 15 uL (40sets/pck)	/	Al	6.0	4.0	15	500	3	235	○	○	—	○	○	—	17
18	GCA-0018	Sealed Pans & Covers (Al) 3.0MPa 70 uL (40sets/pck)	/	Al	6.0	8.0	70	500	3	235	○	—	—	—	—	—	18
19	GCA-0022	Sealed Pans & Covers (Ag) 5.0MPa 15 uL (20sets/pck)	/	Ag	6.0	4.0	15	600	5	264	○	○	—	○	○	—	19
20	GCA-0021	Sealed Pans & Covers (Ag) 5.0MPa 70 uL (20sets/pck)	/	Ag	6.0	8.0	70	600	5	264	○	—	—	—	—	—	20
21	GCA-0023	Sealed Pans & Covers (SS) 5.0MPa 15 uL (20sets/pck)	/	SUS	6.0	4.0	15	600	5	264	○	○	—	○	○	—	21
22	GCA-0051	Sealed Pans & Covers (SS) 5.0MPa 70 uL (20sets/pck)	/	SUS	6.0	8.0	70	600	5	264	○	—	—	—	—	—	22
23	GAA-0462	Slid. Pans & Cvr. (Gold-plated SS) 5.0MPa 15 uL (10sets/pck)	/	SUS/Au	6.0	4.0	15	500	5	264	○	○	—	○	○	—	23
Open Pans for Auto Sampler (DSC)																	
24	GAA-0065	RDC Sample Pan (Al) 15 uL φ6.8 h2.5 (200pcs/pck)	25 GAA-0064	Al	6.8	2.5	15	600	/	/	—	○	—	○	○	—	24
25	GAA-0064	RDC Sample Pan Cover (Al) φ6.8 (200pcs/pck)	24 GAA-0065	Al	6.8	/	/	600	/	/	—	○	—	○	○	—	25
PDC Sample Pans, Plates, and Others																	
26	GCA-0057	PDC Open Sam. Pan (Al) 50 uL φ7.2 h1.5 (200pcs/pck x 2pcks)	27 K-YSSC000E036	Al	7.2	1.5	50	600	/	/	—	—	—	○	○	—	26
27	K-YSSC000E036	PDC Open Sam. Pan Cover (Al) φ7.0 (200pcs/pck x 2pcks)	26 GCA-0057	Al	7.0	/	/	600	/	/	—	—	—	○	○	—	27
28	GCA-0020*3	PDC Sample Plate (Al) φ6.5 (200pcs/pck)	/	Al	6.5	/	/	150	/	/	—	○	—	○	○	—	28
	K-YSSC000C007	Reshaping Tool for Platinum Pan	5 CSF-6410 / 6 CSF-6411	/	/	/	/	/	/	/	—	—	—	—	—	—	

*1 DSC7000X and X-DSC7000 are same model although named differently depending on the delivery date.

*2 STA and TG/DTA are named depending on release dates, but both correspond to EXSTAR 6000 series, TA7000 series and NEXTA STA series.

*3 Applicable for PDC equipped only.

*4 When using low-pressure sealed pan (40 μL), option sample tray is required.

*5 Temperature at which saturated water vapor pressure reaches maximum pressure of the pan.

○ : available
 — : unavailable
 / : not apply

Sample Sealer

Electrical Sample Sealer

Every crimp and sealing operation can be done by Electrical Sample Sealer with pressure detection technology. Because of this, human error will be avoided during sealing, and will also be effective for measurements which require high repeatability or pressure resistance.

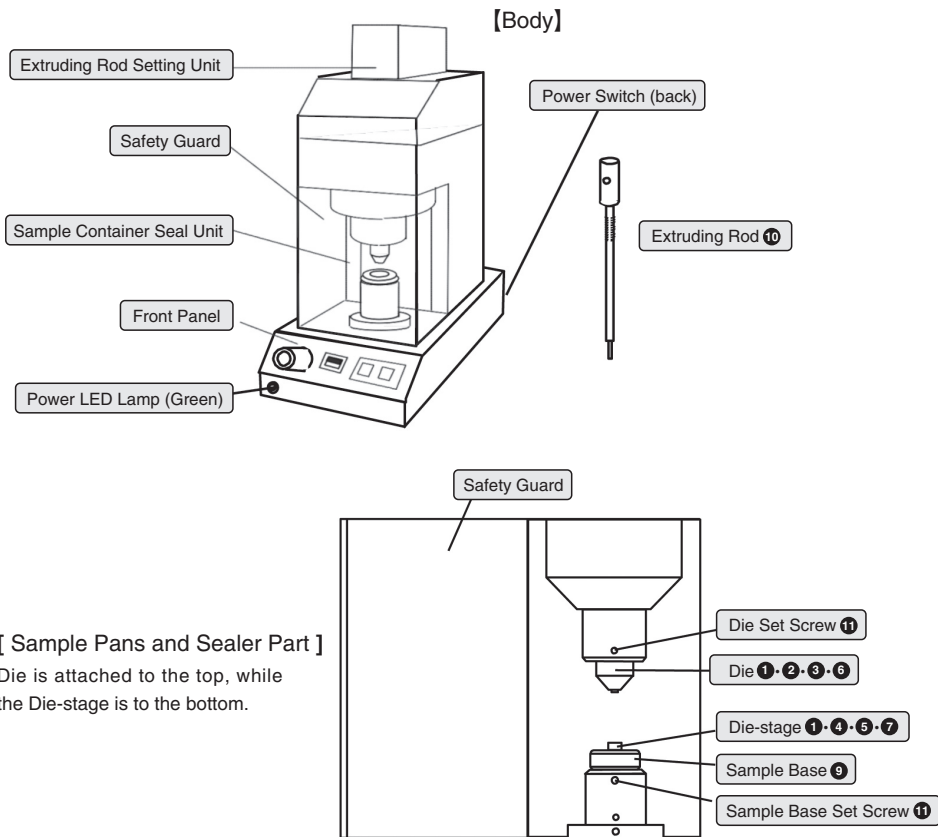

Sample Sealer





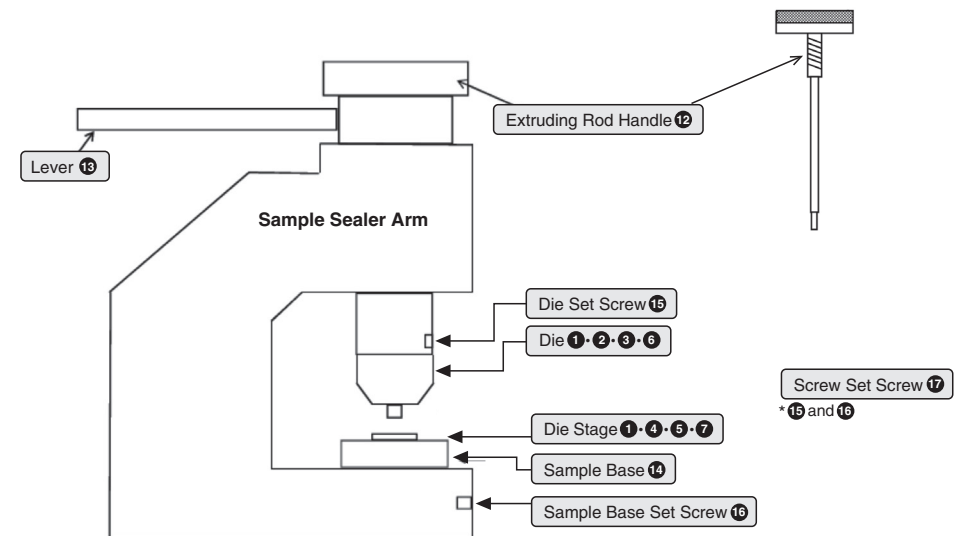



Manual Sample Sealer

Manually seals both open and sealed types of pans.



Sample Sealer

Die and Die-stage Set

	Crimp Die & Die-stage Set	Low-pressure Seal Die & Die-stage Set	High-pressure Seal Die & Die-stage Set	Auto Sampler Crimp Die & Die-stage Set
Name	Crimp Die	Low-pressure Sealed Die	High-pressure Sealed Die	Auto Sampler Crimp Die
				
Features	Engraved mark. The protrusion at the tip is shorter than the low-pressure sealed die. Deep groove.	The protrusion at the tip of is shorter than crimp die. No groove.	Through hole at the center of the die.	Spring is used. Grooved.
Parts List	①	②	③	⑥
Name	Crimp Die-stage	Low and High-pressure Seal Die-stage (dual purpose)		Auto Sampler Crimp Die-stage
				
Features	Spring is used. Engraved mark.	Low-pressure: Deep hole High-pressure: Shallow hole		One side hole only.
Parts List	①	④	④	⑦
Usable Pans	Al Open Pan (+Crimp Cover) Al Open Pan (+Plate)	Low-pressure sealed pan · Untreated pan · Chromated Pan	High-pressure sealed pans · Material: Al, Ag, SUS · Size: 15 µL, 70 µL	Auto Sampler Crimp Pan

* When using 40 µL low-pressure sealed die, die stage ⑤ is needed.

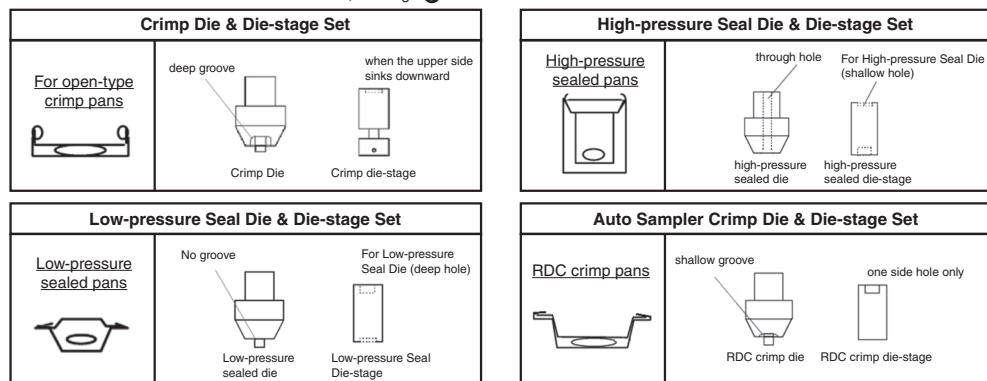

Manual / Electric Sample Sealers Common Parts

No.	Part Number	Part Name	Remarks
①	K-YSSC000C002	Die & Die-stage Set for Crimp Pans	
②	K-YSSC520C001	Die for Low-pressure Hermetic Pans (w/o groove)	
③	K-Y560-304	Die for High-pressure Hermetic Pans	
④	K-Y560-305	Die-stage for High / Low-pressure Hermetic Pans	
⑤	CVB-0004	Die-stage for Low-pressure 40uL Hermetic Pans	Low-pressure 40uL Sealer only
⑥	K-Y50-313	Die for RDC Pan (Auto Sampler Pan)	
⑦	K-YSSC527B001	Die-stage for RDC Pan (Auto Sampler Pan)	
⑧	K-Y52-764	Die Presser Plate	For Low-pressure Die with groove only

Electrical Sample Sealer Parts

No.	Part Number	Part Name	Remarks
⑨	★ K-W10100719	Sample Base for Electric Sample Sealer	
⑩	★ K-YSSC000E151	Extruding Rod for Electric Sample Sealer	
⑪	★ K-W10100654	Set Screws for Die and Sample Base of Electric Sample Sealer	Die side : 4mm × 6mm (1pc) Die-stage side : 4mm × 10mm (1pc)

Manual Sample Sealer Parts

No.	Part Number	Part Name	Remarks
⑫	K-W10100071	Extruding Rod and Handle for Manual Sample Sealer	
⑬	K-YSSC520B004	Lever for Manual Sample Sealer	
⑭	★ K-Y50-315	Sample Base for Manual Sample Sealer	
⑮	★ K-W10100428	Set Screw for Die of Manual Sample Sealer	SUS 4 mm × 4 mm (1pc)
⑯	★ K-W10100429	Set Screw for Sample Base of Manual Sample Sealer	SUS 6 mm × 25 mm (1pc)
⑰	K-YSSC000B001	Set Screws for Die and Sample Base of Manual Sample Sealer	Die side : 4 mm × 4 mm (1pc) Sample Base side : 6 mm × 25 mm (1pc)

Parts for Thermomechanical Analyzer (TMA) (TMA/SS)

**TMA7000 Series (TMA/SS7000 Series)
TMA/SS6000 Series A-Type (Delivery starting July 1999)**

Outline Drawing

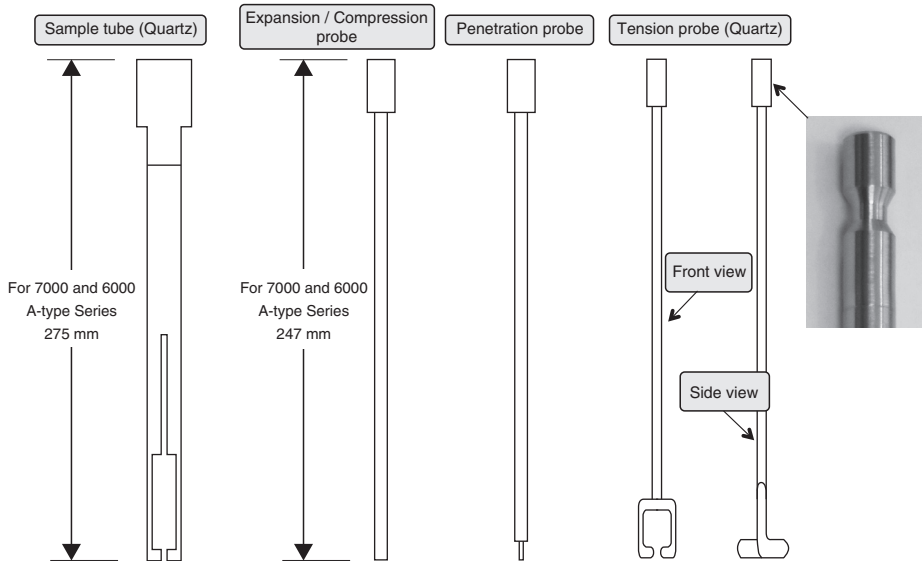
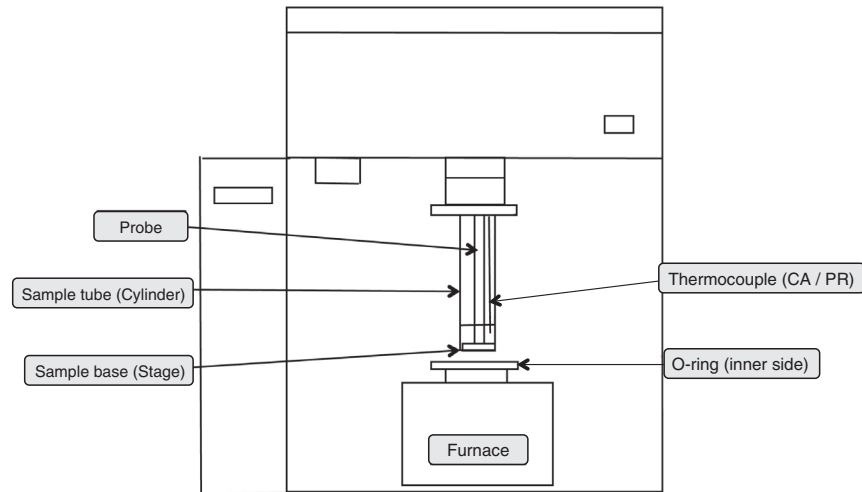

TMA/SS6000 Series O-Type (Delivery until June 1999)

Outline Drawing

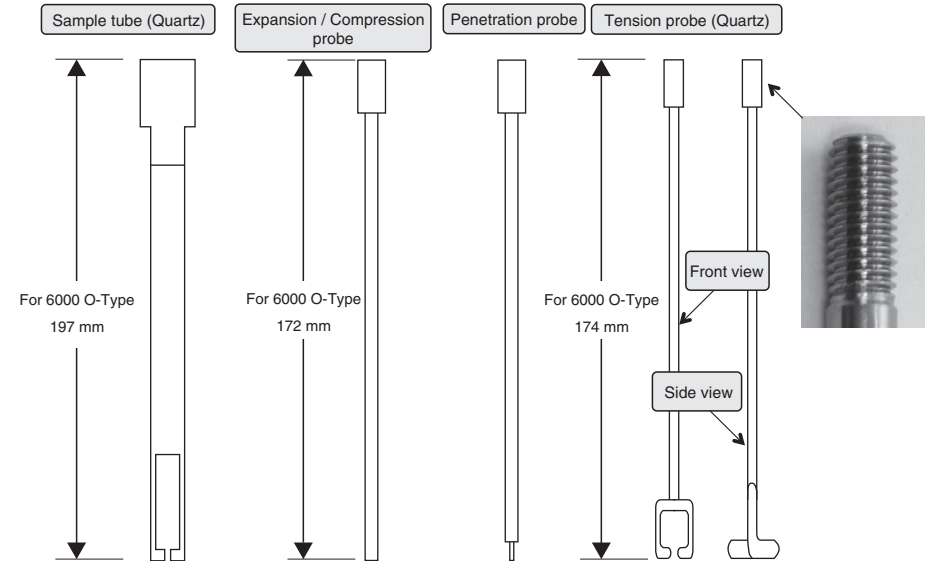
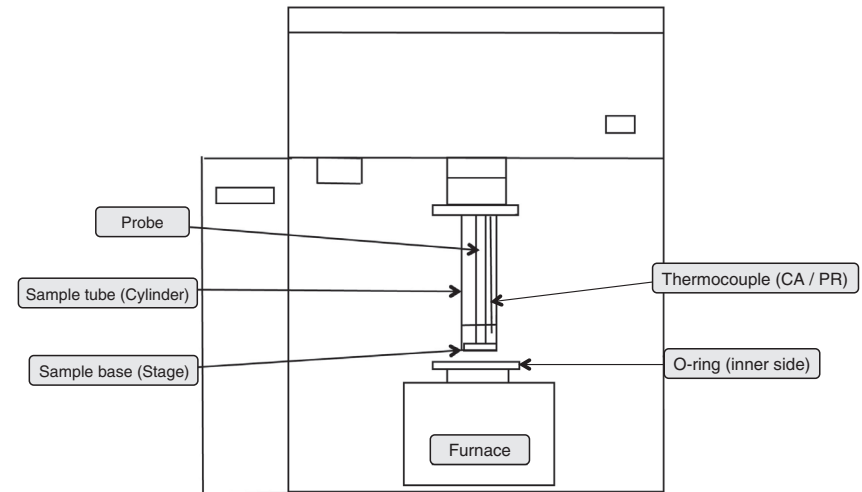

Parts for Thermomechanical Analyzer (TMA) (TMA/SS)

Part Number	Part Name	Applicable Products		
		TMA7000 (TMA/SS 7000)	*TMA/SS 6000 Series -A-Type	*TMA/SS 6000 Series -O-Type

Probes and Chucks

Part Number	Part Name	TMA7000 (TMA/SS 7000)	*TMA/SS 6000 Series -A-Type	*TMA/SS 6000 Series -O-Type
GAA-0472	Quartz Expansion Probe (A-type)	○	○	—
GAA-0473	Ceramic Expansion Probe (A-type)	○	○	—
K-YSSC578D004	Quartz Expansion Probe (O-type) Mounting side is screw type	—	—	○
★ K-YSSC578D005	Ceramic Expansion Probe (O-type) Mounting side is screw type	—	—	○
GAA-0477	Quartz Penetration Probe (A-type, ϕ 1.0 mm tip) Diameter of flat tip is 1.0 mm	○	○	—
GAA-0478	Quartz Penetration Probe (A-type, ϕ 0.5 mm tip) Diameter of flat tip is 0.5 mm	○	○	—
GAA-0480	Quartz Penetration Probe (A-type, Conical tip) Shape of the tip is Conical	○	○	—
K-YSSC578D006	Quartz Penetration Probe (O-type, ϕ 1.0 mm tip) Tip diameter is 1.0 mm / Screw-type mounting	—	—	○
K-YSSC578D012	Quartz Penetration Probe (O-type, ϕ 0.5 mm tip) Tip diameter is 0.5 mm / Screw-type mounting	—	—	○
★ K-YSSC578D034	Quartz Penetration Probe (O-type, Conical tip) Tip is Conical / Screw-type mounting	—	—	○
K-YSSC578D045	Quartz Tension Probe (A-type, 4 mm Width)	○	○	—
GAA-0532	Quartz Tension Probe (5 mm Width)	○	—	—
K-YSSC578D013	Quartz Tension Probe (O-type, 4 mm Width) Mounting side is screw type	—	—	○
K-YSSC578D046	Metal Tension Probe (A-type)	○	○	—
★ K-YSSC578D014	Metal Tension Probe (O-type) Mounting side is screw type	—	—	○
K-YSSC575C005	Quartz Tension Chuck set (4 mm Width) For Quartz Tension Probe & Sample Tube sides	○	○	○
K-W10100771	Quartz Tension Chuck set (5 mm Width) For Quartz Tension Probe & Sample Tube sides	○	—	—
K-Y50-659	Metal Tension Chuck set (4 mm Width) Probe & Sample Tube sides / Mounting screws are sold separately	○	○	○
K-W10100959	Metal Tension Chuck set (5 mm Width) Probe & Sample Tube sides / Mounting screws are sold separately	○	—	—

(★) For TMA/SS6000 series, A-Type equipment are being delivered starting July 1999, while O-Type equipment were up until June 1999. For details, please refer to the previous page (1-9, 1-10).

Part Number	Part Name	Applicable Products		
		TMA7000 (TMA/SS 7000)	*TMA/SS 6000 Series -A-Type	*TMA/SS 6000 Series -O-Type

Probe Sets and Other Accessories

Part Number	Part Name	TMA7000 (TMA/SS 7000)	*TMA/SS 6000 Series -A-Type	*TMA/SS 6000 Series -O-Type
K-YSSC578D047	Quartz Probe (A-type) & Chuck set (4 mm Width) Both Probe and Chuck included	○	○	—
★ GAA-0592	Quartz Probe & Chuck set (5 mm Width) Both Probe and Chuck included	○	—	—
★ K-YSSC578D007	Quartz Probe (O-type) & Chuck set (4 mm Width) Both Probe and Chuck included / Screw type mounting	—	—	○
K-YSSC575B012	Screws for Metal Tension Chuck set (5pcs/pck) Screws for securing Metal Tension Chuck	○	○	○
K-Y58M-669	Screws for Quartz or Metal Tension Chuck set (5pcs/pck) Securing sample mounting for Tension Chuck	○	○	○
K-YSSC575C006	Jig for Sample mounting (4 mm Width)	○	○	○
GAA-0566	Jig for Sample mounting (For both 4 mm & 5 mm Width) Sample mounting jig	○	○	○
GAA-0499	Quartz Bending Probe (A-type) No Bending Platform included	○	—	—
K-YSSC578D015	Quartz Bending Probe (O-type) No Bending Platform included	—	—	○
K-YTAA-915	Quartz Bending Platform	○	○	○
GAA-0479	Quartz Bending Probe & Platform set (A-type) Bending Platform included	○	○	—

Sample Tubes

Part Number	Part Name	TMA7000 (TMA/SS 7000)	*TMA/SS 6000 Series -A-Type	*TMA/SS 6000 Series -O-Type
★ GAA-0467	Quartz Sample Tube (A-type) without Thermocouple	○	○	—
K-YSSC578D039	Metal Sample Tube (A-type) without Thermocouple	○	○	—
K-Y10100023	Ceramic Sample Tube (A-type) without Thermocouple	○	○	—
★ K-YSSC578D016	Quartz Sample Tube (O-type) without Thermocouple	—	—	○
★ K-YSSC578D018	Metal Sample Tube (O-type) without Thermocouple	—	—	○
K-W10100790	Ceramic Sample Tube (O-type, modified) without Thermocouple	—	—	○
GAA-0469	Quartz Sample Tube (A-type) with K-type Thermocouple Thermocouple is attached to the sample tube	○	○	—

Parts for Thermomechanical Analyzer (TMA) (TMA/SS)

Part Number	Part Name Remarks	Applicable Products		
		TMA7000 (TMA/SS 7000)	* TMA/SS 6000 Series -A-Type	*TMA/SS 6000 Series -O-Type
K-YSSC578D002	Quartz Sample Tube (O-type) with K-type Thermocouple Thermocouple is attached to the sample tube	—	—	○
K-Y10100020	Metal Sample Tube (A-type) with K-type Thermocouple Thermocouple is attached to the sample tube	○	○	—
★ K-YSSC578D035	Metal Sample Tube (O-type) with K-type Thermocouple Thermocouple is attached to the sample tube	—	—	○
GAA-0470	Quartz Sample Tube (A-type) with R-type Thermocouple Thermocouple is attached to the sample tube	○	○	—
★ K-YSSC578D001	Quartz Sample Tube (O-type) with R-type Thermocouple Thermocouple is attached to the sample tube	—	—	○
★ K-Y10100021	Metal Sample Tube (A-type) with R-type Thermocouple Thermocouple is attached to the sample tube	○	○	—
★ K-YSSC578D019	Metal Sample Tube (O-type) with R-type Thermocouple Thermocouple is attached to the sample tube	—	—	○
★ GAA-0471	Ceramic Sample Tube (A-type) with R-type Thermocouple Thermocouple is attached to the sample tube	○	○	—
K-W10100798	Ceramic Sample Tube (O-type, modified) with R-type TC Thermocouple is attached to the sample tube	—	—	○

Thermocouples

K-YSSC578D026	K-type Thermocouple for A-type Sample Tube	○	○	—
K-YSSC578D026O	K-type Thermocouple for O-type Sample Tube	—	—	○
K-YSSC578D027	R-type Thermocouple for A-type Sample Tube	○	○	—
K-YSSC578D027O	R-type Thermocouple for O-type Sample Tube	—	—	○

Sample Stages

GAA-0540	Quartz Sample Stage ϕ 12 mm (5pcs/pck)	○	○	○
★ K-YSSC578D028	Ceramic Sample Stage ϕ 11 mm (O-type, 5pcs/pck)	—	—	○
GAA-0534	Ceramic Sample Stage ϕ 15 mm (A-type, 3pcs/pck)	○	○	—

Furnace Tubes

K-YSSC578D020	Quartz Furnace Tube	○	○	○
K-YSSC578D021	Ceramic Furnace Tube	○	○	○

Part Number	Part Name Remarks	Applicable Products		
		TMA7000 (TMA/SS 7000)	* TMA/SS 6000 Series -A-Type	*TMA/SS 6000 Series -O-Type
Miscellaneous				
K-W10100884	Aluminum Standard ϕ 5 mm x L10 mm (0507-12-22A-4)	○	○	○
K-YSSC520B008	Sapphire Plates ϕ 5.50 mm x h0.31 mm (5pcs/pck)	○	○	○
GAA-0489	Thermal Expansion Measurement Kit Sapphire Container (Outer ϕ 7.0 mm, Inner ϕ 5.5 mm, h3.0 mm), Sapphire Plate (ϕ 5.5 mm, Thickness: 0.3 mm), and Spatula	○	○	—
K-YSSC507B004	Silicon O-ring (G25) (5pcs/pck) For Furnace Tube	○	○	○
GCA-0056	Viscous Fluid Cup and Pin Set (100set/pck) For thermosetting applications	○	○	○
GAA-0556	TMA Low Load Tension Measurement Clip (1pc) For tensile measurements	○	○	○

TMA Quartz Tension Top & Bottom Chuck Sets

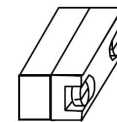

Top Chuck

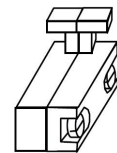

Bottom Chuck

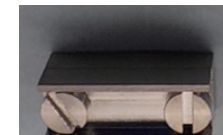

K-W10100771
Up to 5 mm Sample Width



K-YSSC575C005
Up to 4 mm Sample Width

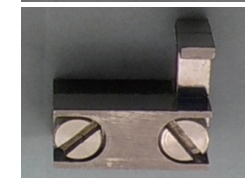
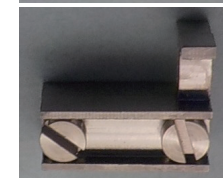

Parts for Differential Scanning Calorimeter (DSC)

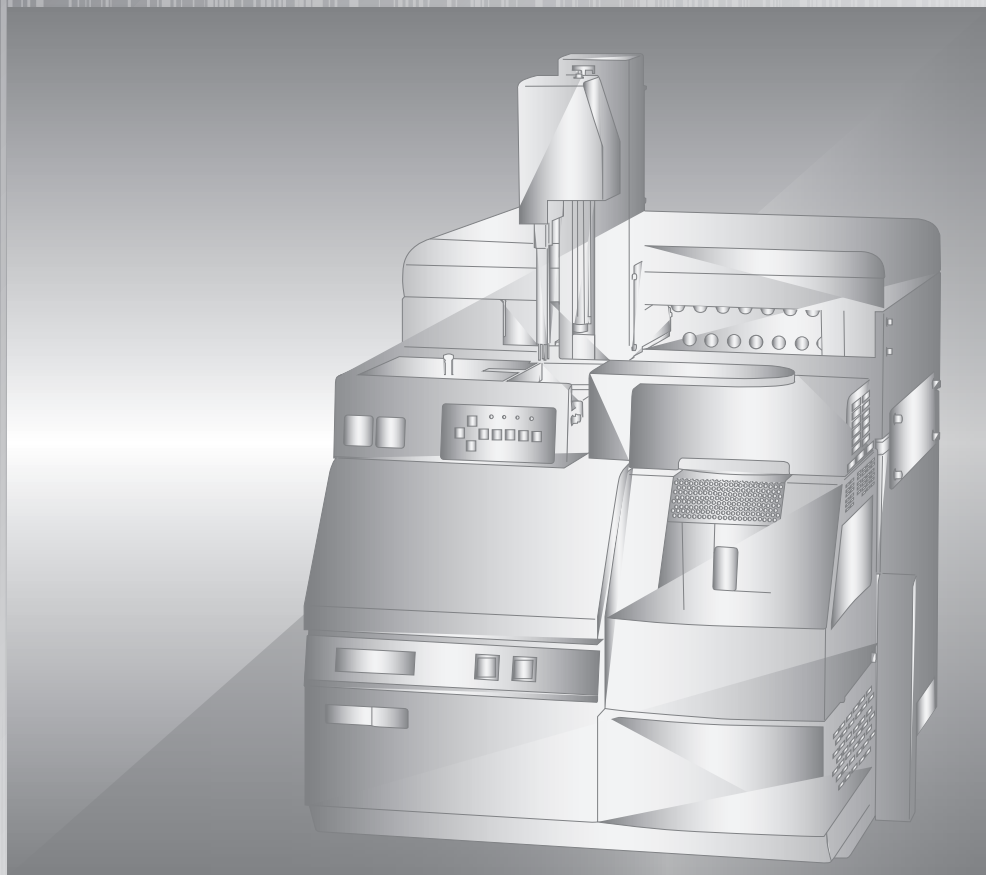

Parts for Differential Scanning Calorimeter (DSC)

Part Number	Part Name Remarks	Applicable Products				
		7000X	7020	6300	6200 6220	6100
K-Y56US-115	Sapphire Plate, ϕ 3.5 (10 mg)	○	○	○	○	○
	Plate: Aluminium Oxide (Al ₂ O ₃) 10 mg x 1 plate					
GAA-0433	Sapphire Plate Set, ϕ 3.5 (10 mg x 2, 20 mg x 1, 30 mg x 1)	○	○	○	○	○
	10 mg x 2 sheets, 20 mg x 1 sheet, 30 mg x 1 plate					
★ K-W10100750	Jacket Lid for X-DSC7000	○	-	-	-	-
	Material: Aluminum (Al) and Stainless Steel (SS)					
★ K-W10100142	Inner Lid for Heat Sink (Silver, ϕ 26.6 mm)	○	○	-	○	-
	Material: Silver (Ag)					
★ K-W10100168	Inner Lid for Heat Sink (Silver, ϕ 23.0 mm) for DSC6100	-	-	-	-	○
	Material: Silver (Ag)					
K-W10101090	Inner Lid for Heat Sink, Anti-adhesion (Silver, ϕ 26.6 mm)	○	○	-	○	-
	To prevent fusion bonding of lid to heat sink					
★ K-W10100706	Outer Lid Window for RV-1D/1DX (2pcs/pck)	○	○	-	-	-
	Material: Heat-resistant Glass					
K-W10100707	Inner Lid Window for RV-1D (2pcs/pck)	-	○	-	-	-
	Material: Quartz Glass					
K-W10100708	Inner Lid Window for RV-1DX (2pcs/pck)	○	-	-	-	-
	Material: Aluminum, Heat-resistant Glass, and Stainless Steel					
★ GAA-1911	Heat-resistant Sheet for Cooling Can (10sheets/pck)	-	○	-	○	○
	For condensation prevention while cooling					
K-YSSC520B008	Sapphire Plates (5pcs/pck)	-	-	-	○	-
K-YSSC000C007	Reshaping Tool for Platinum Pan (50-024, 035)	○	○	○	○	○
	Open-type Sample Pan (Pt), ϕ 5.2, both h2.5 and h5.0					
K-W10100987	Jig Set for Powder Samples	○	○	○	○	○
	Used for DSC and STA sampling					

Auto Gas Cooling Unit

6000 Series / 7000 Series

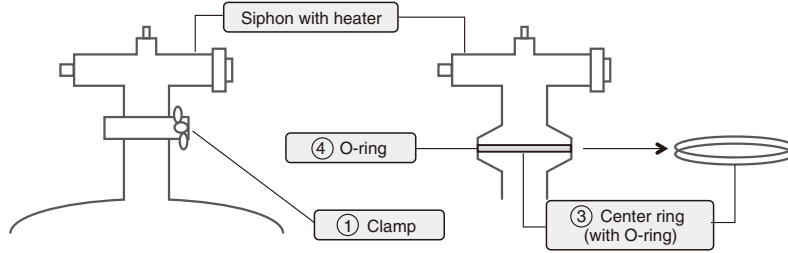

6000 Series

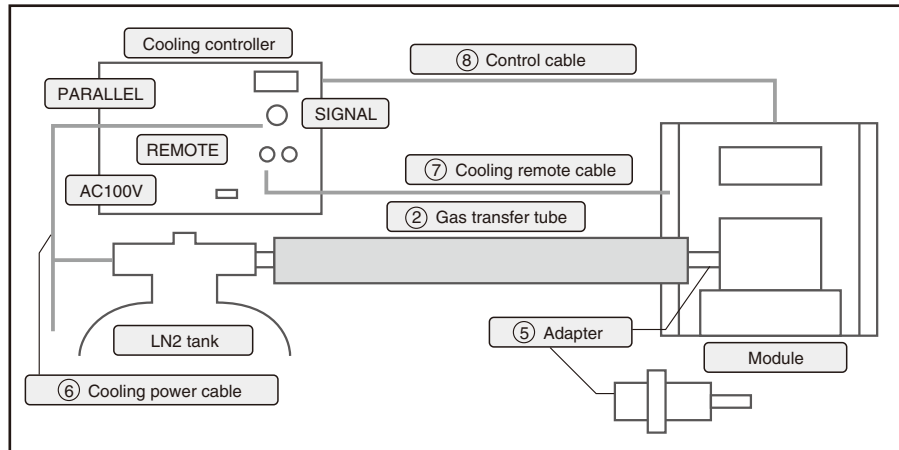

7000 Series

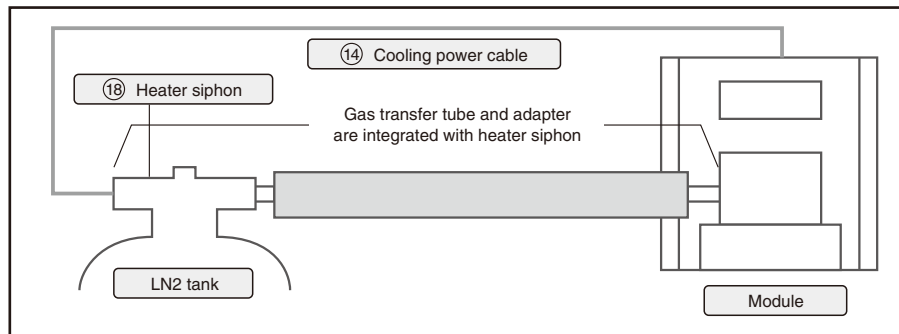

Auto Gas Cooling Unit

6000 Series

No.	Part Number	Part Name	Qty
①	K-YTAA-989	Clamp, NW40 (ACA) (Auto Gas Cooling Unit Accessory)	1pc
②	K-YTAA-990	Gas Transfer Tube (Black) (Auto Gas Cooling Unit Accessory)	1pc
③	K-Y52E-020	Center Ring, NW40-CR316L (ACA) (Auto Gas Cooling Unit Accessory)	1pcs/set
④	K-YSSC541B003	O-rings (2pcs/pck) (Auto Gas Cooling Unit Accessory)	2pcs/set
⑤	K-YSSC541B001	Adapter for Tube (Auto Gas Cooling Unit Accessory)	1pc
⑥	K-Y52E-022	Cooling Power Cable (Heater Cable) (Auto Gas Cooling Unit Accessory)	1pc
⑦	K-W10100631	Cooling Remote Cable	1pc
⑧	K-W10100751	Control Cable (ACA) for EXSTAR (1 meter)	1pc
⑨	★ K-W10100996	30L Dewar for 7000 Series (EXSTAR6000 compatible using Container Adapter)	1pc
⑩	★ K-W10100995	Container Adapter DX-AD-01 (NW50 x NW40) for 7000 Series Dewar conversion	1pc
⑫	★ K-W10100058	30L Dewar Trolley (with stopper) for Auto Gas Cooling Unit	1pc

7000 Series

No.	Part Number	Part Name	Qty
⑬	K-W10100842	Clamp for 7000 Series Auto Gas Cooling Unit	1pc
⑭	K-W10100677	Cooling Power Cable (Heater Cable) for 7000 Series Auto Gas Cooling Unit	1pc
⑮	K-W10100920	Center Ring for 7000 Series Auto Gas Cooling Unit	1pcs/set
⑯	K-W10100921	O-rings (2pcs) for 7000 Series Auto Gas Cooling Unit	2pcs/set
⑰	★ K-W10101100	30L Heater Siphon (SP-100-30S) for 7000 Series Auto Gas Cooling Unit (100Vac)	1pc
⑱	★ K-W10100602	Fully Automatic Gas Cooling Unit, 7000 Series (30L Heater Siphon + Tank)	1pc
⑲	★ K-W10100970	30L LN2 Tank (ND-30S) for 7000 Series Auto Gas Cooling Unit	1pc
⑳	K-W10100631	Cooling Remote Cable	1pc
㉑	★ K-W10101093	30L Heater Siphon (SP-220-30S) for 7000 Series Auto Gas Cooling Unit (220Vac)	1pc

Parts for Simultaneous Thermogravimetric Analyzer (STA) (TG/DTA)



Parts for Simultaneous Thermogravimetric Analyzer (STA) (TG/DTA)

Part Number	Part Name	Applicable Products(TG/DTA)					
		NEXTA STA200RV	NEXTA STA200,300	STA 7200RV	STA 7200,7300	STA 7220	TG/DTA 6200,6300
GAA-0628	Balance Beam Set (socket plug-in ready, 2 beams/set) For TG/DTA6200, 6300 with replacement procedure manual	○	○	○	○	○	○
K-YSSC519C001	Balance Beam Set, RTG220 (additional soldering required, 2 beams/set) Solder work cost is required separately	-	-	-	-	-	○
GAA-1985	Furnace Tube (standard type) With flange	-	○	-	○	-	○
K-YSSC594D010	Furnace Tube (vacuum type) With flange	-	-	-	-	-	○
K-YSSC594D015	Lamp with Holder and Connector	-	-	-	-	-	○
K-W10100255	Lamp Block (U-type) and Connector	-	-	-	-	-	○
K-YSSC517B002	Packing Bellows (5pcs/pck)	-	-	-	-	-	○
★ K-W10101207	Packing for TA7000 (seal width: 2 mm)	-	-	○	○	○	-
K-W10100033	O-ring (P20-4D) for Furnace Tube	○	○	○	○	○	○
GAA-0755	Furnace Tube for STA7200RV Furnace Tube Replacement Jig is required	-	-	○	-	-	-
GAA-0763	Furnace Tube Replacement Jig for STA7200RV	-	-	○	-	-	-
K-YSSC000C007	Reshaping Tool for Platinum Pan (50-024, 035) For Open-type Sample Pan (Pt), ϕ 5.2, h2.5 and h5.0.	○	○	○	○	○	○

Parts for Dynamic Mechanical Analyzer (DMA) (DMS)

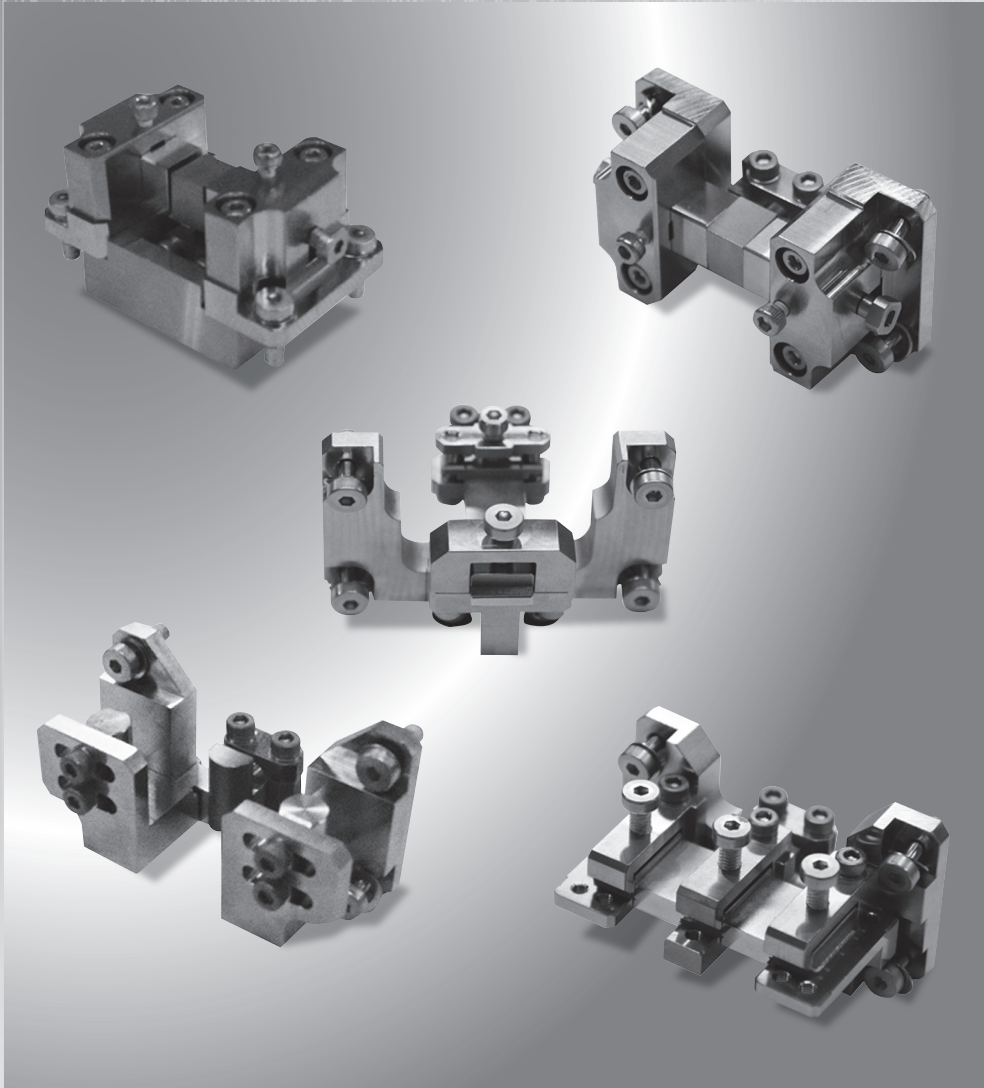

Parts for Dynamic Mechanical Analyzer (DMA) (DMS)

Part Number	Part Name Remarks	Applicable Products	
		DMA 7100	DMS 6100
K-YSDM551D001	Aluminum Calibration Plate (40 mm x 3 mm x 0.1 mm) (10pcs/set)	○	○
K-YSDM551D002	Pure Iron Calibration Plate (0.4 mm x 10 mm x 50 mm)	○	○
K-YSDM552D003	Pure Stainless Steel Calibration Plate (3 mm x 10 mm x 50 mm)	—	○
K-W10101095	Tension Attachment Sample Gap Setting Plate for DMA7100 Alignment jig for upper and lower sides	○	—
★ K-W10101142	Bending Attachment Sample Gap Setting Plate for DMA7100 Alignment jig for upper and lower sides	○	—
K-YSDM564D002	PMMA Sample (0.2 mm x 8 mm x 40 mm) (10pcs/set)	○	○
GAA-0966	PMMA Sample (1.5 mm x 10 mm x 50 mm) (20pcs/set)	○	○
K-W10100974	Tension Attachment (Base Side) for DMA7100	○	—
K-W10100973	Tension Attachment (Probe Side) for DMA7100	○	—
K-YSSC564D008	Tension Attachment (Base Side) for DMS6100	—	○
K-YSSC564D009	Tension Attachment (Probe Side) for DMS6100	—	○
AGU-0029	Bending Attachment Set for DMA7100 Both base and probe sides of Bending Attachment	○	—
K-YSDM564D003	Tension Attachment Sample Gap Setting Plate for DMS6100 Alignment jig for upper and lower sides	—	○
K-YSDM564D004	Bending Attachment Sample Gap Setting Plate for DMS6100 Alignment jig for upper and lower sides	—	○
★ K-YSSC564D001	Tension Attachment Set for DMS6100 Both base and probe sides of Tension Attachment	—	○
★ K-YSSC564D002	Bending Attachment Set (20 mm) for DMS6100 Both 20mm base and probe sides of Bending Attachment	—	○
★ K-YSSC564D006	Bending Attachment Set (32 mm) for DMS6100 Both 32mm base and probe sides of Bending Attachment	—	○
★ K-YSSC564D005	Bending Attachment Set (8 mm) for DMS6100 Both 8mm base and probe sides of Bending Attachment	—	○
K-YSSC564D007	Bending Attachment (Probe Side, 20 mm) for DMS6100 20mm probe side of Bending Attachment only	—	○
★ K-YSDM551B002	O-ring (4CG95) for DMS6100 Furnace fixture O-ring	—	○
★ K-W10100668	Screws (Stainless Steel) M3x6 (4pcs/set) for Tension Attachment For sample thickness 0-1mm (Standard for sample mounting), DMA6100	—	○
★ K-W10100228	Screws (Stainless Steel) M3x8 (4pcs/set) for Tension Attachment For sample thickness 1-3mm (Standard for sample mounting), DMA6100	—	○
★ K-W10100198	Screws (Stainless Steel) M3x10 (4pcs/set) Standard for all kinds of attachments for DMA6100	—	○